

NECCHI
Instruction Manual

Q421A

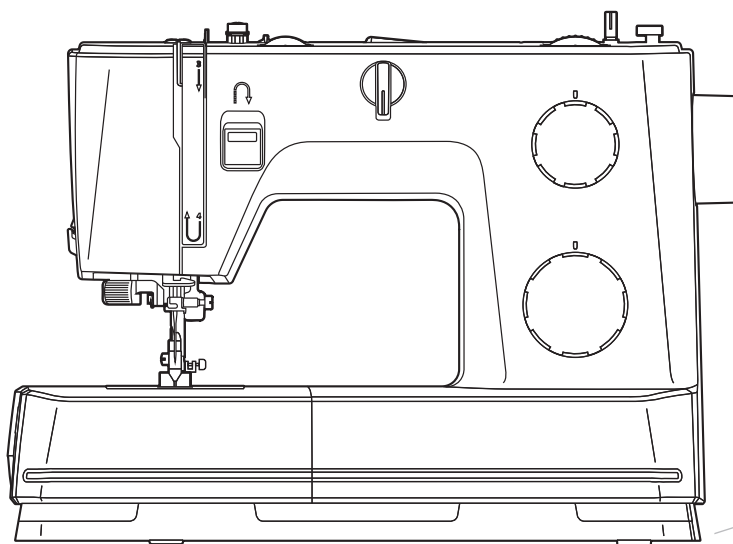

Important safety instructions

When using an electrical appliance, basic safety should always be followed, including the following:

Read all instructions before using this sewing machine.

DANGER - To reduce the risk of electric shock:

1. An appliance should never be left unattended when plugged in.
2. Always unplug this appliance from the electric outlet immediately after using and before cleaning.

WARNING - To reduce the risk of burns, fire, electric shock, or injury to persons:

1. Read the instruction carefully before you use the machine
2. Keep the instructions at a suitable place close to the machine and hand it over if you give the machine to a third party.
3. Use the machine only in dry locations.
4. Never leave the machine unattended with children or elderly people as they may not be able to estimate the risk.
5. This appliance can be used by children aged from 8 years and above and persons with reduced physical, sensory or mental capabilities or lack of experience and knowledge if they have been given supervision or instruction concerning use of the appliance in a safe way and understand the hazards involved.
6. Children shall not play with the appliance.
7. Cleaning and user maintenance shall not be made by children without supervision.
8. Always switch off the machine if you carry out preparation for work (change the needle, feed the yarn through the machine, change the footer, etc.).
9. Always unplug the machine if you leave it unattended, to avoid injury by expediently switch on the machine.
10. Always unplug the machine if you changing the lamp or carry out maintenance (oiling, cleaning).
11. Don't use the machine if it's wet or in humid environment.
12. Never pull at the cord, always unplug the machine by gripping the plug.
13. If the LED lamp is damaged or broken, it must be replaced by the manufacturer or it's service agent or a similarly qualified person, in order to avoid a hazard.

14. Never place anything on the pedal.
15. Never use the machine if the air vents are blocked, keep the air vents of the machine and the foot pedal free from dust, fusel and leftovers.
16. The machine must only be used with designated foot controller, in order to avoid a hazard. If the foot controller is damaged or broken, it must be replaced by the manufacturer or its service agent or a similarly qualified person.
17. The power cord of the foot controller can not be replaced. If the power cord is damaged the foot controller must be disposed of.
18. The sound pressure level at normal operation is smaller than 75dB(A).
19. Do not dispose of electrical appliances as unsorted municipal waste, use separate collection facilities.
20. Contact your local government for information regarding the collection systems available.
21. If electrical appliances are disposed of in landfills or dumps, hazardous substances can leak into the groundwater and get into the food chain, damaging your health and well-being.
22. When replacing old appliances with new ones, the retailer is legally obligated to take back your old appliance for disposal at least for free of charge.
23. The appliance is not to be used by persons (including children) with reduced physical, sensory or mental capabilities, or lack of experience and knowledge, unless they have been given supervision or instruction. (For outside Europe)
24. Children being supervised not to play with the appliance. (For outside Europe)

SAVE THESE INSTRUCTIONS

This sewing machine is intended for household use only.

Be sure to use the sewing machine in the temperature range from 5°C to 40°C. If the temperature is excessively low, the machine can fail to operate normally.

Contents

Machine Introduction	1
Principal parts of the machine	2
Accessories	3
Standard.....	3
Optional.....	3
Connecting machine to power source	4
Polarized plug information	4
Foot control	4
Machine Setup	5
Sewing table	6
Two-step presser foot lifter	6
Free arm.....	6
Installing the extension table	7
Adjust presser foot pressure	7
Winding the bobbin	8
Inserting the bobbin	10
Threading the upper thread	11
Using the needle threader (depends on models)	13
Replacing the needle	14
Matching needle/fabric/thread	15
Changing the presser foot	16
Remove the presser foot.....	16
Attach the presser foot.....	16
Remove and insert the presser foot holder.....	16
Insert the edge/quilting guide.....	16
To raise or drop the feed dogs	17
Thread tension	18
Sewing Basics	19
How to choose your pattern	20
Straight stitch	21
Three needle position dial	21
Adjusting the stitch length.....	21
Zigzag stitch	22
Adjusting the stitch length	22
Adjusting the stitch width	22
Starting to sew	23
Useful skills	25
Reverse sewing.....	25
Sewing curves.....	25
Sewing corners	26
Sewing stretch fabrics.....	26
Sewing thin fabrics.....	26
Sewing heavy fabric.....	27
Utility Stitches	28
Stretch stitch	29
Straight stretch stitch	29

Zigzag stretch stitch	29
Sewing stretch fabrics and elastic tape	30
Overcasting stitch.....	31
Blind Hem	32
4-Step Buttonhole stitch	33
Making a buttonhole on stretch fabrics.....	34
Left and right side balance for buttonhole	34
Button sewing	35
Zipper insertion.....	36
Inserting a centered zipper	36
Inserting a side zipper.....	37
Gathering	38
Smocking.....	39
Free motion darning, embroidery and monogramming	40
Preparation for embroidering and monogramming.....	40
Darning.....	41
Embroidery.....	41
Monogramming.....	41
Quilting	42
Using the edge/quilting guide.....	42
Joining the pieces of the fabric	42
Non-stick foot	43
Patchwork stitching	43
Applique.....	44
Fagoting	44
Scallop stitch.....	45
Scallop edging.....	45
Shell tuck stitching	45
Twin needle.....	46
Maintenance and Trouble shooting	47
Maintenance	48
Clean the machine surface	48
Clean the hook	48
Trouble shooting guide	49



Machine Introduction

Principal parts of the machine

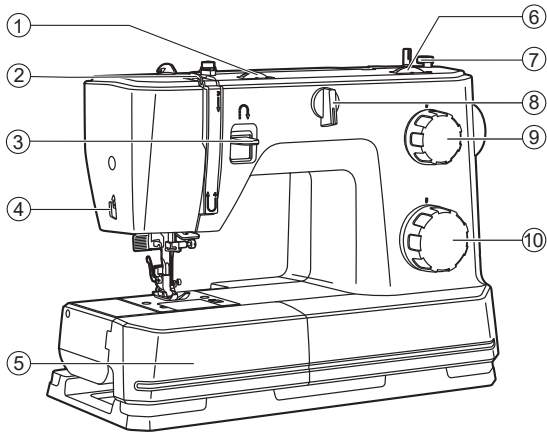

1. Tension dial (page 18)
2. Take-up lever
3. Reverse sewing lever (page 25)
4. Thread cutter (page 24)
5. Sewing table and accessory box (page 6)
6. Stitch width dial (page 20)
7. Bobbin winder stopper (page 8)
8. Three needle position dial (page 21)
9. Stitch length dial (page 20)
10. Pattern selector dial (page 20)

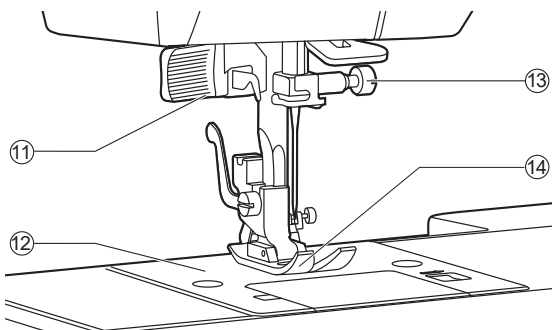

11. Needle threader (depends on models) (page 13)
12. Needle plate (page 48)
13. Needle clamp screw (page 14)
14. Presser foot (page 16)
15. Horizontal spool pin (page 11)
16. Bobbin winder spindle (page 8)
17. Second spool pin hole (page 46)

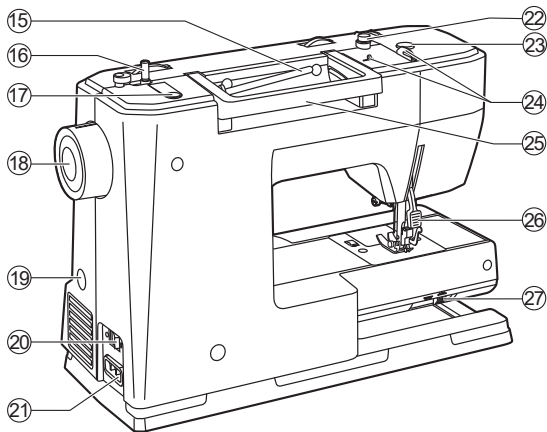

18. Handwheel
19. Buttonhole balance control dial (page 34)
20. Power switch (page 4)
21. Power cord socket (page 4)
22. Bobbin thread guide (page 8)
23. Adjust presser foot pressure (page 7)
24. Upper thread guide (page 11)
25. Handle
26. Presser foot lifter (page 6)
27. Drop feed lever

Accessories

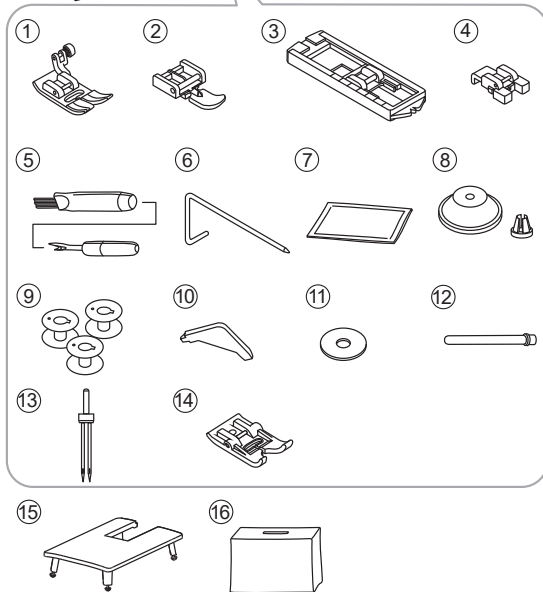
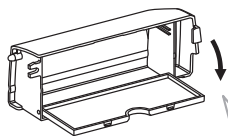

Accessories are stored inside the accessory box.

❖ Standard

1. All purpose foot (already installed)
2. Zipper foot
3. Buttonhole foot
4. Button sewing foot
5. Seam ripper/brush
6. Edge/quilting guide
7. Pack of Needle: 3x single needles (80/11,90/14,100/16)
8. Spool holder
9. Bobbin (4x) (1x already installed)
10. L-screwdriver
11. Spool pin felt
12. Second spool pin
13. Twin needle
14. Non-stick foot
15. Extension table
16. Soft cover

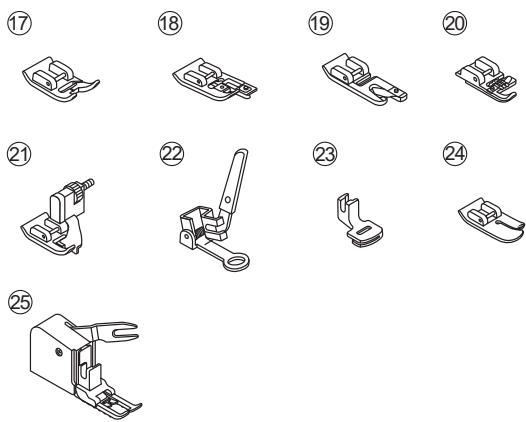

❖ Optional

17. Satin stitch foot
18. Overcasting foot
19. Hemmer foot
20. Cording foot
21. Blind hem foot
22. Darning/embroidery foot
23. Gathering foot
24. Quilting foot
25. Walking foot

Note

To purchase optional accessories, please consult your local dealer for further information.

Connecting machine to power source

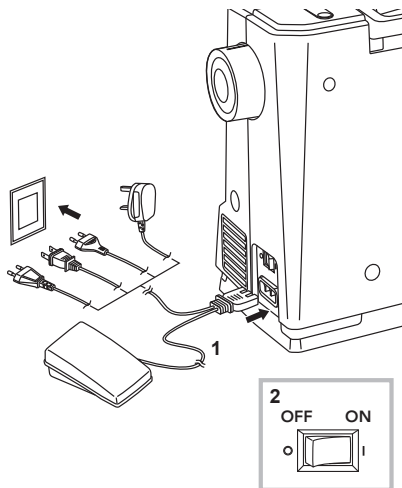

⚠ Attention

Always make sure that the machine is unplugged from power source and the main switch is off ("O"), when the machine is not in use and before inserting or removing parts.

Before connecting the power supply, make sure that the voltage shown on the rating plate is conforming with your main power.

Put the machine on a stable table.

1. Connect the machine to a power source as illustrated.
2. Turn the power switch to on ("I").

The sewing lamp will light up when the switch is turned on.

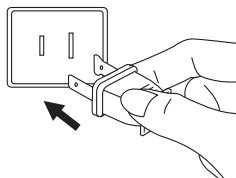

❖ Polarized plug information

This appliance has a polarized plug (one blade is wider than the other), to reduce the risk of electrical shock; this plug will fit in a polarized outlet only one way. If the plug does not fit fully in the outlet, reverse the plug. If it still does not fit, contact a qualified electrician to install the proper outlet. Do not modify the plug in any way.

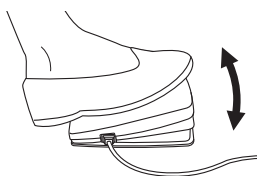

❖ Foot control

When the machine is off, insert the foot control plug into its connector on the machine.

Turn on the machine, and then slowly press down the foot control to start sewing. Release the foot control to stop the machine.

User can quickly kick one step on the foot control to change the needle position and set the stop position at the same time.

Note

Consult a qualified electrician if in doubt as to connect the machine to the power source.

The page features decorative geometric patterns in the top and bottom corners. These patterns consist of a network of thin grey lines connecting small grey dots, forming a complex web. Overlaid on this network are several solid grey shapes, including triangles and polygons of various sizes and orientations. The top-left pattern includes a large, dark grey triangle pointing downwards. The top-right pattern features a large, dark grey triangle pointing upwards. The bottom-left pattern shows a large, dark grey triangle pointing downwards, partially overlapping another dark grey shape. The bottom-right pattern includes a large, dark grey triangle pointing upwards, also partially overlapping other shapes. The central text is positioned between these decorative elements.

Machine Setup

Sewing table

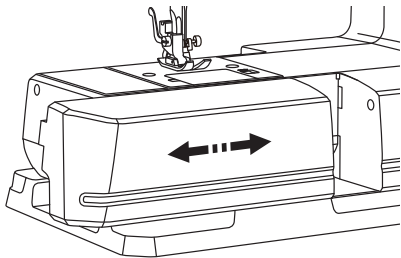

Hold the sewing table horizontally, then pull toward the left to remove it from the machine.

Attach the sewing table, and then push it to the right.

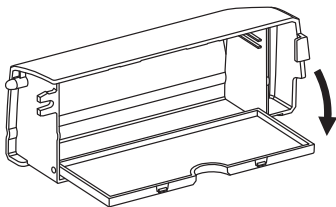

The inside space of the sewing table is used as an accessory box.

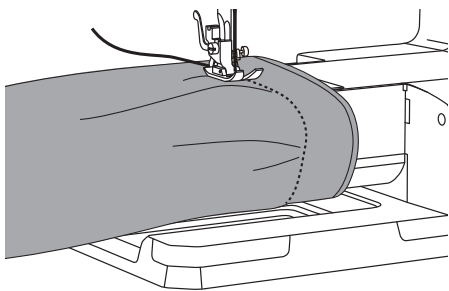

❖ Free arm

Free-arm sewing is convenient for sewing tubular areas such as pant hems and cuffs.

Two-step presser foot lifter

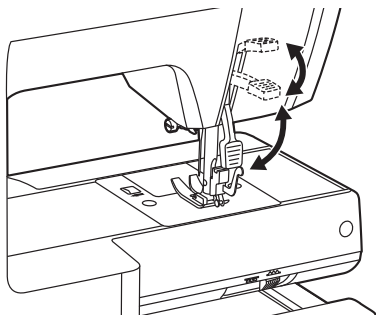

The presser foot lifter is to raise or lower your presser foot.

When sewing multi-layers or thick fabrics, the presser foot can be further raised up manually to allow enough space for your sewing work.

Note

The needle must always be at the highest position.

Installing the extension table

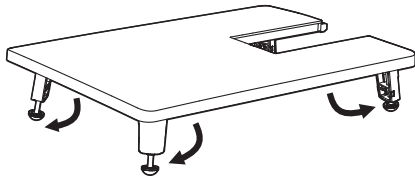

Pull the sewing table and accessory box off by sliding it to the left.

Follow the arrow, and stretch the foot of the extension table.

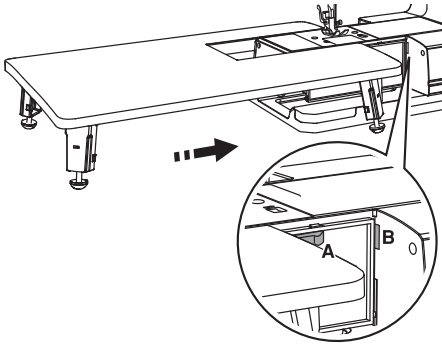

Snap (A) of the extension table into (B) of the machine.

Adjust presser foot pressure

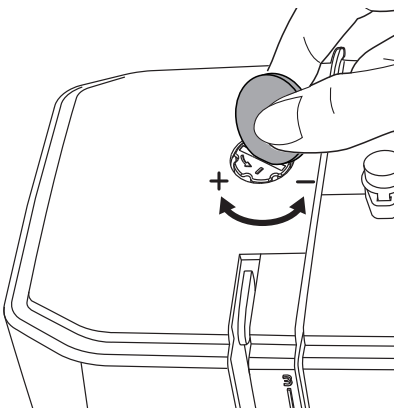

The presser foot pressure of the machine has been pre-set and requires no particular readjustment according to the type of fabric (light-or-heavy weight).

However, if you need to adjust the presser foot pressure, turn the presser adjusting screw with a coin.

For sewing very thin fabric, loosen the pressure by turning the screw counter clockwise, and for heavy fabric, tighten by turning it clockwise.

Winding the bobbin

Please following the number order and see the corresponding illustrations below.

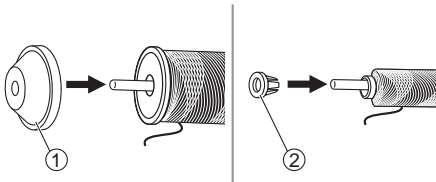
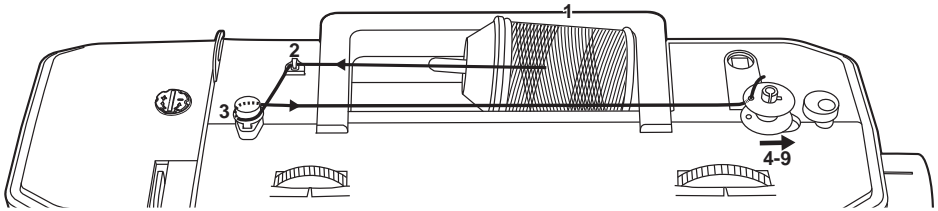

1. Place the thread and spool holder onto the spool pin. For better sewing quality, choose a proper size of the spool holder for the thread and attach it next to the spool.

- ① Large spool holder
- ② Small spool holder

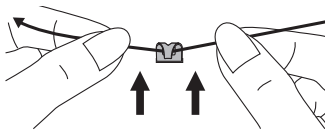

2. Draw the thread from the spool and place the thread in between the upper thread guide.

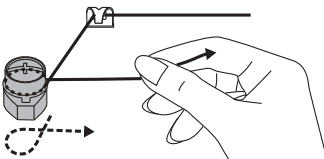

3. Wind the thread clockwise around the tension discs.

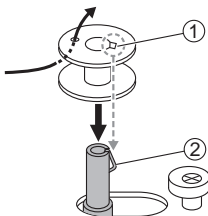

4. Place the thread end through one of the inner holes as illustrated and place the empty bobbin on the bobbin winder spindle. Then align the notch with bobbin winder spindle spring.

- ① Notch
- ② Bobbin winder spindle spring

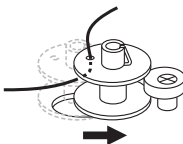

5. Push the bobbin to the right.

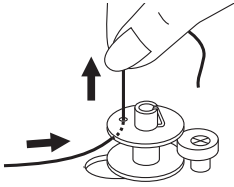

6. Hold the thread tail securely in one hand.

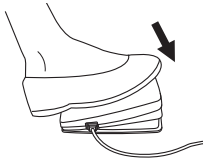

7. Step on the foot control to start winding the bobbin.

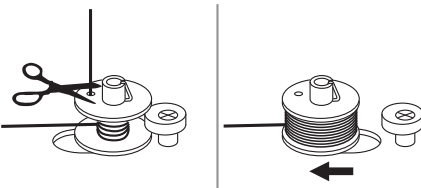

8. After the bobbin has wound a few rounds, stop the machine and cut the thread near the hole of the bobbin. Continue filling the bobbin until it is full. Once the bobbin is full, it rotates slowly. Release the foot control to stop the machine, then push the bobbin winder spindle to the left.

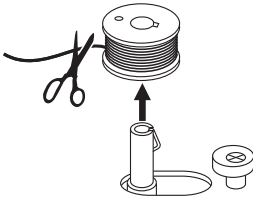

9. Cut the thread and then remove the bobbin.

Note

When the bobbin winder spindle is pushed to the right position, it's in "bobbin winding" mode and the machine is not allowed to sew and the handwheel will not be able to turn. To start sewing, push the bobbin winder spindle back to the left.

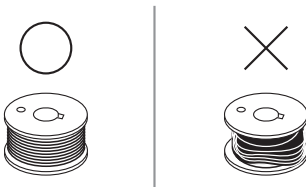

Note

Use a bobbin that has been correctly wound with thread, otherwise the needle may break or the thread tension will be incorrect.

Inserting the bobbin

⚠ Attention

Turn the power switch to off ("O").

When inserting or removing the bobbin, the needle and the presser foot must be fully raised.

Open the bobbin cover by pushing the release button to the right.

① Release button

Insert the bobbin in the bobbin case with the thread running in a counter-clockwise direction (arrow).

Pull the thread through the slit (A).

With a finger hold gently on top of the bobbin, please follow the arrow markings and draw the thread into the bobbin thread guide from (A) to (B).

Follow the arrow markings and draw the thread into the bobbin thread guide from (B) to (C).

To cut off excessive thread, pull it to the cutter at point (C).

Close the bobbin cover.

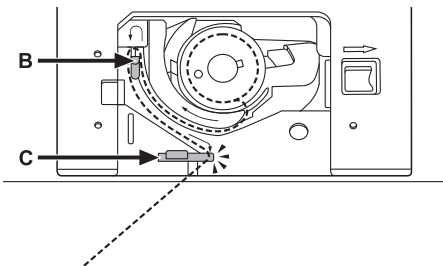
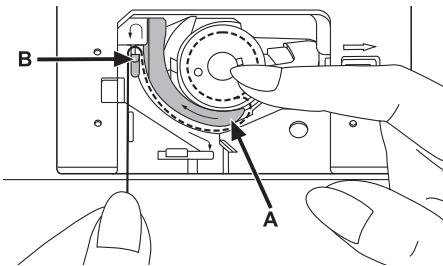
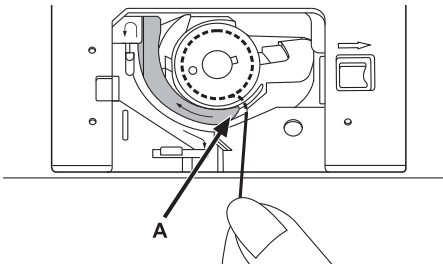
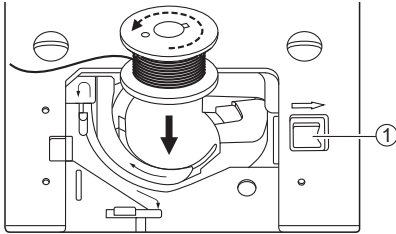

Threading the upper thread

Please follow the number order and see the corresponding illustrations below. It is important to carry out the threading correctly to get sewing quality. Otherwise several problems will occur.

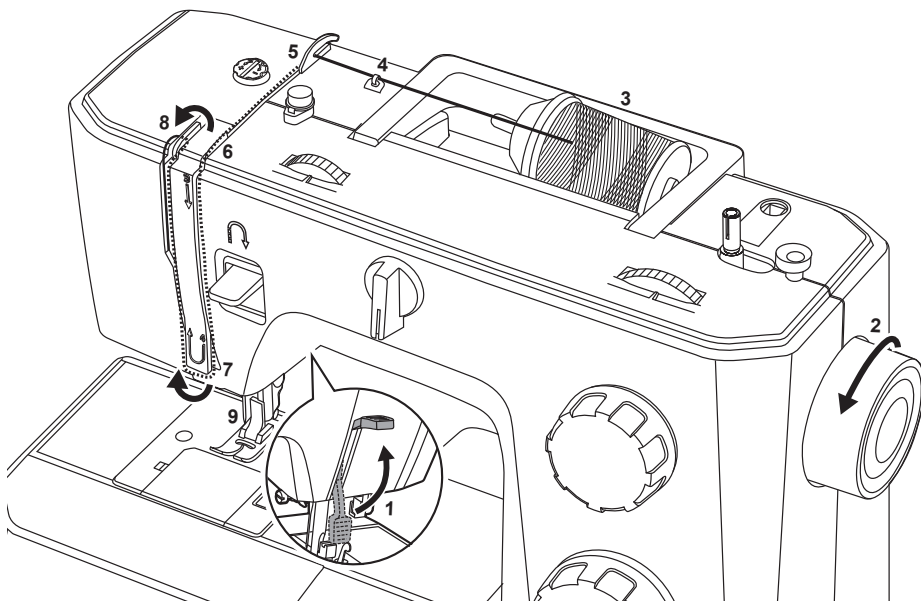

▲ Attention
Turn the power switch to off ("O").

1. Raise the presser foot lifter.
2. Turn the handwheel towards you to bring the needle and take-up lever to highest position.

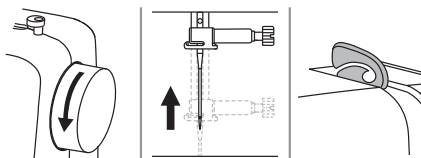

3. Place the thread and spool holder onto the spool pin. For better sewing quality, choose a proper size of the spool holder for the thread and attach it next to the thread.

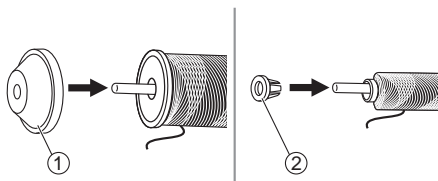

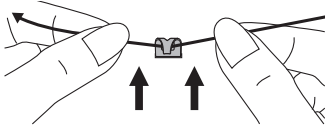

4. Draw the thread from the spool and place the thread in between the upper thread guide.

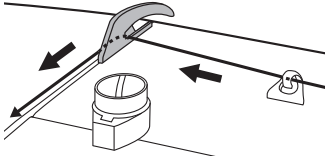

5. Guide the thread ahead and pull the thread through the pre-tension spring as illustrated.

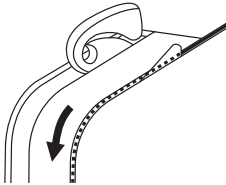

6. Continue to guide the thread into the silver discs to keep the thread in proper tension.

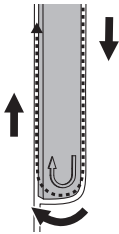

7. Pass the thread under the take-up spring then pull it upwards as arrow marks illustrated.

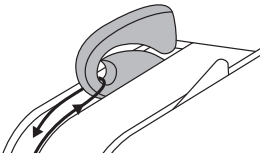

8. Pull the thread to the top then pass the thread through the slotted eye of the take-up lever. Guide the thread down afterwards.

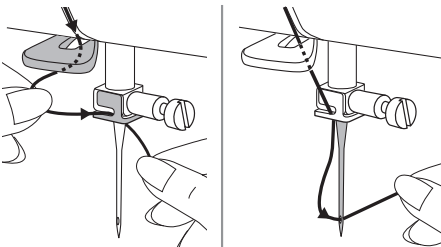

9. Pass the thread behind the flat, horizontal thread guide.

Pull the end of the thread through the needle from front to rear and pull out about 10 cm of thread.

Using the needle threader (depends on models)

▲ Attention

Turn the power switch to off ("O").

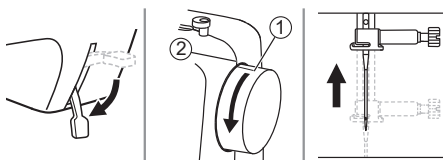

Lower the presser foot lifter. Raise the needle to its highest position by turning the handwheel toward you until the mark matched with the line on the machine.

- ① Mark
- ② Line on the machine

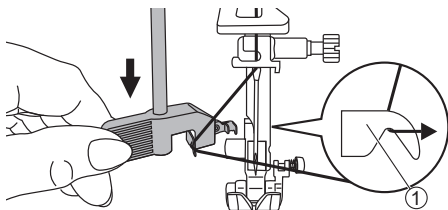

Press down the needle threader for a certain distance and cross the thread over the thread guide.

- ① Thread guide

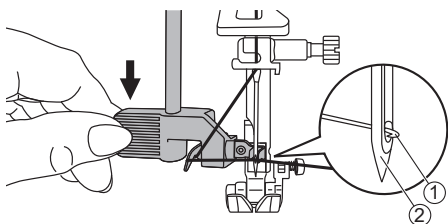

Press down the needle threader as far as it goes.

The needle threader turns automatically to the threading position and the hook pin passes through the needle eye.

- ① Hook pin
- ② Needle

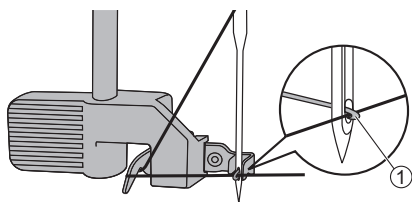

Take the thread in front of the needle and make sure it is under the hook pin.

- ① Hook pin

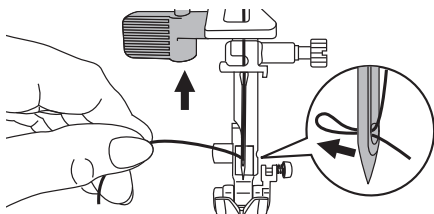

Hold the thread loosely and release the lever slowly. The hook turns and passes the thread through the needle eye forming a loop.

Pull the thread through the needle eye.

Replacing the needle

Change the needle regularly, especially when it shows signs of wear or if it causes problems.

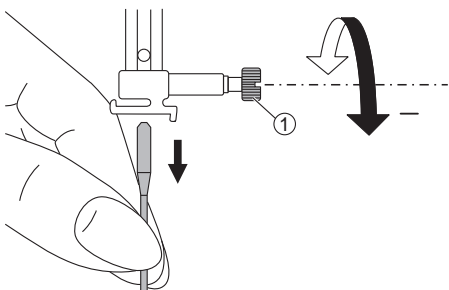

⚠ Attention

Turn the power switch to off ("O") when carrying out below operations!

Turn the handwheel toward you to raise the needle then loosen the needle clamp screw to remove the needle.

① Needle clamp screw

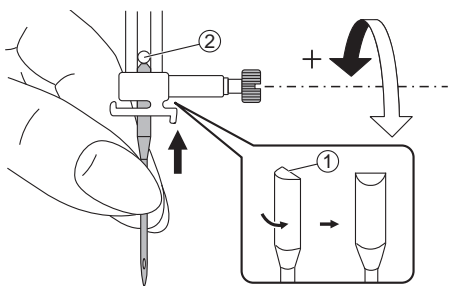

When inserting a new needle, keep the flat side of the shaft to the back.

Push the needle into the clamp until it touches the pin and stops. Then secure it by tightening the needle clamp screw.

① Flat side of the shaft

② Pin

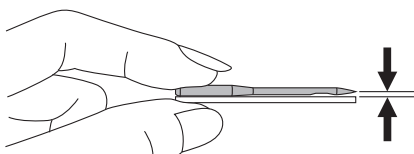

Needles must be in perfect condition.

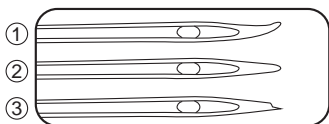





Problems can occur with:

① Bent needles

② Blunt needles

③ Damaged points

Matching needle/fabric/thread

NEEDLE SIZE	FABRICS	THREAD
65/9-75/11 	Lightweight fabrics- thin cottons, voile, serge, silk, muslin, Qiana, interlocks, cotton knits, tricot, jerseys, crepes, woven polyester, shirt & blouse fabrics.	Light-duty thread in cotton, nylon, polyester or cotton wrapped polyester.
80/12 	Medium weight fabrics- cotton, satin, kettlclote, sailcloth, double knits, lightweight woolens.	Most threads sold are medium size and suitable for these fabrics and needle sizes. Use polyester threads on synthetic materials and cotton on natural woven fabrics for best results. Always use the same thread on top and bottom.
90/14 	Medium weight fabrics- cotton duck, woolen, heavier knits, terrycloth, denims.	
100/16 	Heavyweight fabrics- canvas, woolens, outdoor tent and quilted fabrics, denims, upholstery material (light to medium).	

Note

1. In general, fine threads and needles are used for sewing fine fabrics, thicker threads and needles are used for sewing heavy fabrics.
2. Always test thread and needle size on a small piece of fabric which will be used for actual sewing.
3. Use the same thread for needle and bobbin.
4. Use a stabilizer or place a backing for fine or stretchy fabrics, and select the correct presser foot.
5. It is recommended that a 90/14 needle should be used when embroidering on heavyweight fabrics or stabilizing products (for example, denim, puffy foam, etc.). A 75/11 needle may bend or break, which could result in injury.
6. For transparent nylon thread, always use needle 90/14 - 100/16. The same thread is usually used for the bobbin thread and upper threading.

Changing the presser foot

⚠ Attention

Turn the power switch to off ("O") when carrying out any of the operations below!

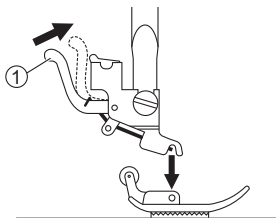

❖ Remove the presser foot

Raise the presser foot lifter. Press the back lever to release the presser foot.

- ① Lever

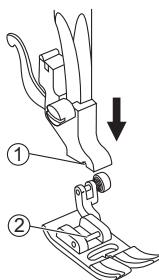

❖ Attach the presser foot

Lower the presser foot lifter until the cut-out meets the pin.

The presser foot will attach to the presser foot holder automatically.

- ① Cut-out
- ② Pin

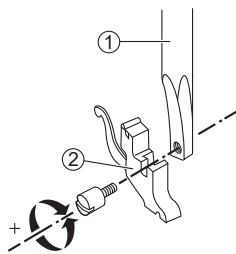

❖ Remove and insert the presser foot holder

Raise the presser foot lifter. Align the presser foot holder with the lower left side of the presser bar. Hold the presser foot holder, then tighten the screw using the enclosed L-screwdriver.

- ① Presser foot bar
- ② Presser foot holder

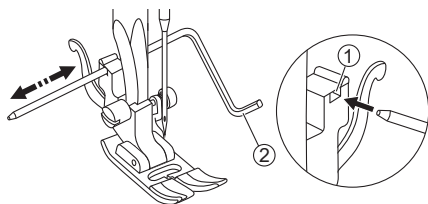

❖ Insert the edge/quilting guide

Insert the edge/quilting guide in the slot as illustrated. Adjust the needed width according to your sewing applications.

- ① Slot
- ② Edge/quilting guide

To raise or drop the feed dogs

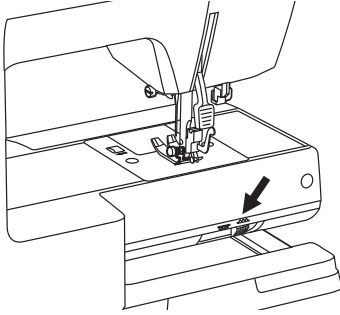

The drop feed lever can be seen on the base at the rear side of the sewing machine.

Sliding the drop feed lever to lower or raise the feed dogs. When lever is in raised position, the feed dog will arise automatically when you are sewing.

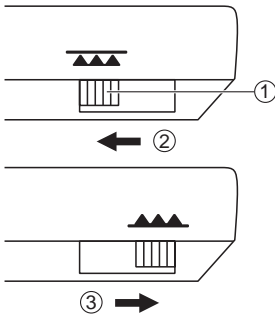

- ① Drop feed lever
- ② Lowered position
- ③ Raised position

Note

When you finish the work, (e.g. button sewing, free motion darning, embroidery and monogramming), please move the drop feed lever to raised position for general sewing purpose.

Thread tension

Proper tension setting is important for sewing. There is no single tension setting appropriate for all the stitch functions and fabrics.

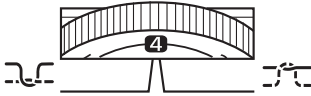

Basic thread tension setting: "4".

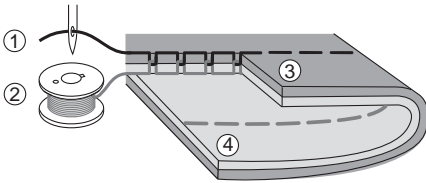

Normal thread tension for straight stitch sewing.

- ① Upper thread
- ② Bobbin thread
- ③ Surface
- ④ Wrong side

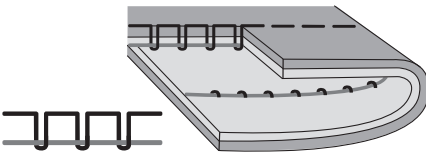

Thread tension is too loose for straight stitch sewing. Turn the dial to the higher number.

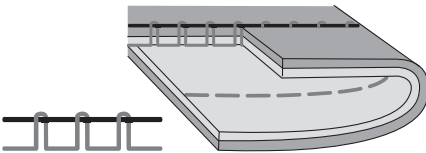

Thread tension is too tight for straight stitch sewing. Turn the dial to the lower number.

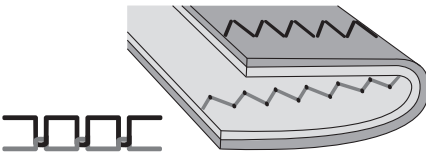

Normal thread tension for zig zag and decorative sewing.

For all decorative sewing you will always obtain a nicer stitch and less fabric puckering.

Correct thread tension is when a small number of the upper thread appears on the bottom side of fabric.



| Sewing Basics

How to choose your pattern

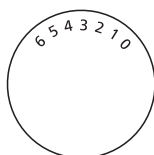
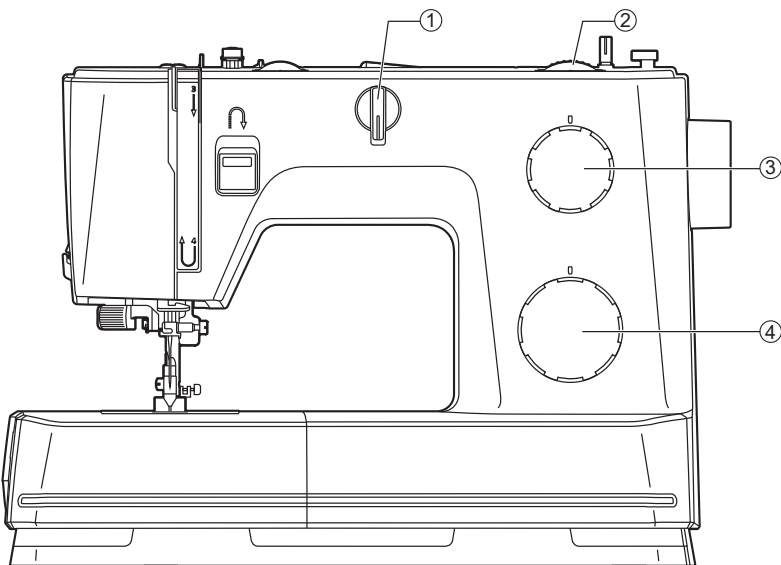

②

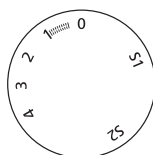

③

To select a stitch, simply turn the pattern selector dial. The pattern selector dial may be turned in either direction.

For straight stitch, select pattern " - - - " with the pattern selector dial.

For zigzag stitch, select pattern " ~ ~ ~ " with the pattern selector dial. Adjust the stitch length and stitch width according to the fabric being used.

To obtain the other patterns, turn the stitch length dial to "S1" or "S2", select the pattern desired with pattern selector dial. (depends on models)

- ① Three needle position dial
- ② Stitch width dial
- ③ Stitch length dial
- ④ Pattern selector dial

Straight stitch



Using the all purpose foot.

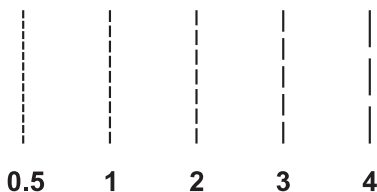

❖ Adjusting the stitch length

Turn the stitch length dial, and the length of the individual stitches will decrease as the dial approaches "0". The length of the individual stitches will increase as the dial approaches "4".

Generally speaking, the thicker the fabric, thread and needle, the longer the stitch should be.

Three needle position dial

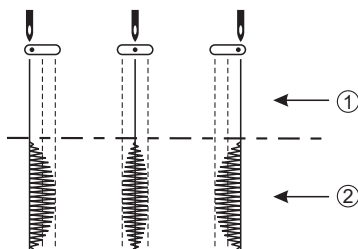

The needle position can be altered with the three needle position dial. For normal work, the needle position is middle. For edge stitching or sewing parallel lines of top stitch, select needle position left or right. For twin needle stitching, needle position is middle.

- ① Straight
- ② Zig-zag

Zigzag stitch

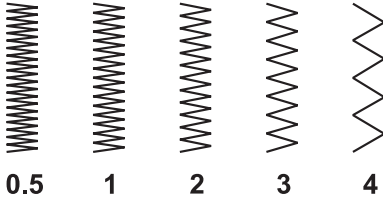

Using the all purpose foot.

❖ Adjusting the stitch length

The density of zigzag stitches increase as the setting of stitch length approaches "0".

Neat zig-zag stitches are usually achieved at "2.5" or below.

Closed up zigzag stitches (close together) are referred to as a satin stitch.

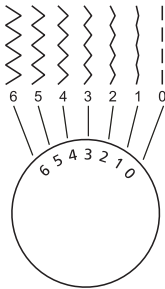

❖ Adjusting the stitch width

The width increases as you move stitch width dial from "0-6".

The width can be reduced on any patterns.

Starting to sew

Make sure you follow the needle/fabric/thread combinations (Page 16) and use the suggested presser foot before sewing.

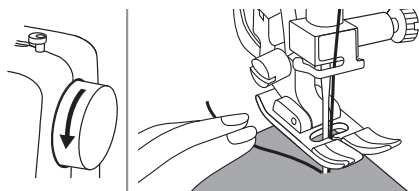
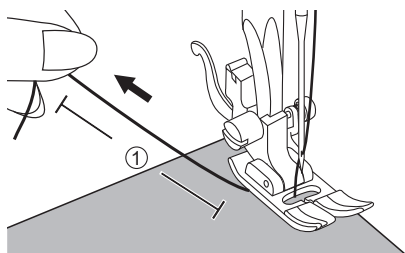

1. Turn the power switch to on ("I").
2. Turn the handwheel towards you (counter-clockwise) to bring the needle to highest position.
3. Raise the presser foot lifter.
Turn the pattern selection dial to select a stitch.
4. Place the fabric under the presser foot, pass the thread under the presser foot, and then pull out about 10cm of thread toward the rear of the machine.
① 10cm
5. Turn the handwheel toward you (counter-clockwise) to lower the needle into the fabric at the beginning of the stitching.
6. Lower the presser foot lifter.

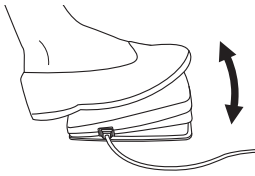

7. Slowly press down the foot control to start sewing. Release the foot control to stop the machine.

Note

You can use reverse sewing for back tacking and reinforcing seams by pressing the reverse sewing lever. Please refer to "Useful skills" chapter (Page 25) for more information.

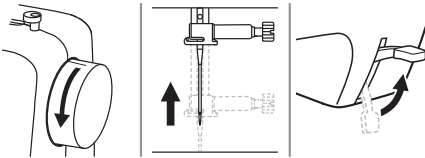

8. Turn the handwheel toward you (counterclockwise) to raise the needle. Raise the presser foot lifter and remove the fabric.

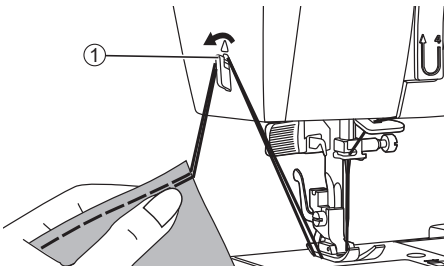

9. Guide both threads to the side of the face plate and into the thread cutter. Pull the threads down to cut them.

① Thread cutter

Useful skills

Various ways to achieve better results for your sewing projects are described below. Refer to these tips when sewing your project.

The results depend on types of fabrics and stitches. Please use the same fabric of the project and do a sewing test in advance.

For the trial sewing, use a piece of fabric and thread that are same as those used for your project and check the thread tension and stitch length and width.

Since the results differ depending on types of stitching and layers of fabric sewn, perform the trial sewing under the same conditions that will be used with your project.

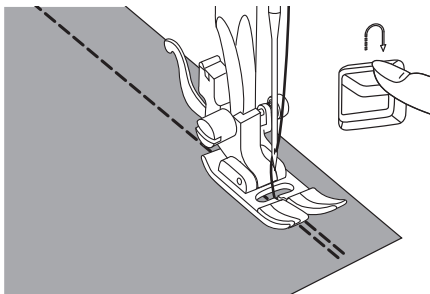

❖ Reverse sewing

Reverse stitching is used to secure the threads at the beginning and at the end of a seam.

Press the reverse sewing lever and sew 4-5 stitches.

The machine will sew forward when the lever is released.

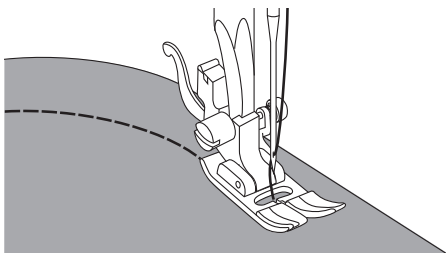

❖ Sewing curves

Slightly change the sewing direction to sew around the curve.

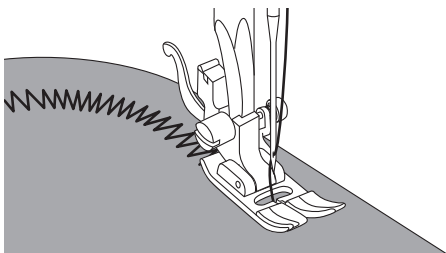

When sewing along a curve while using a zigzag stitch, select a shorter stitch length in order to obtain a finer stitch.

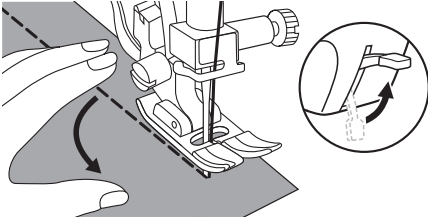

❖ Sewing corners

Stop the sewing machine when you reach a corner.

Lower the needle into the fabric. Raise the presser foot. Use the needle as a pivot and turn the fabric 90°.

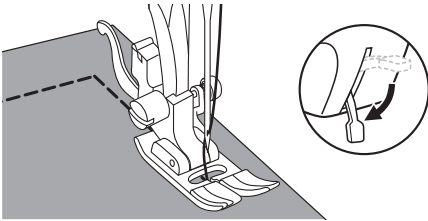

Lower the presser foot and resume sewing.

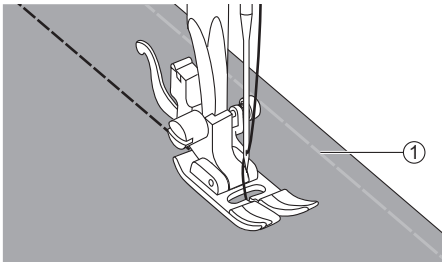

❖ Sewing stretch fabrics

Baste the pieces of fabric together, and then sew without stretching the fabric.

① Basting

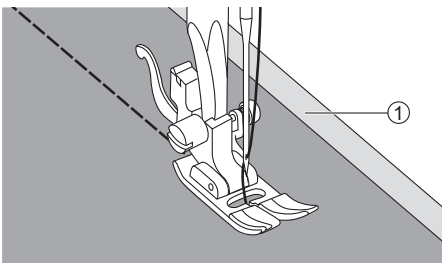

❖ Sewing thin fabrics

When sewing thin fabrics, the stitches may become misaligned or the fabric may not feed correctly. If this occurs, place thin paper or stabilizer material under the fabric and sew it together with the fabric.

When you have finished sewing, tear off any excess paper.

① Stabilizer material or paper

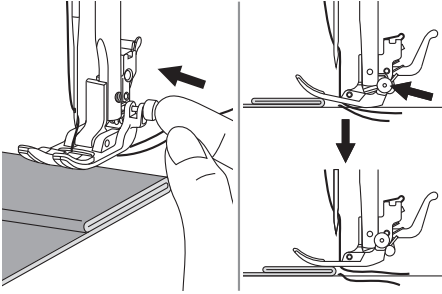

❖ Sewing heavy fabric

The black button on the right side of the presser foot will lock the presser foot in a horizontal position if you push it in before lowering the presser foot.

This ensures even feeding at the beginning of a seam and helps when sewing multiple layers of fabric such as sewing over seams when hemming jeans.

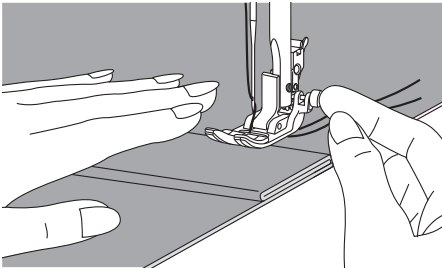

When you reach the point of an increased thickness, lower the needle and raise the presser foot. Press the toe of the foot to the horizontal line and push in the black button, then lower the foot and continue sewing.

The black button releases automatically after sewing few stitches.

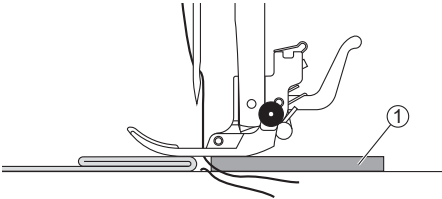

You also can place another piece of fabric with the same thickness at the back of the seam. Or support the presser foot while feeding by hand and sewing toward the folded side.

① Cardboard or thick fabric



Utility Stitches



Stretch stitch

Use this stitch with knitted tricot or other stretchy fabrics. The stitch enables your seam to stretch without breaking the thread.

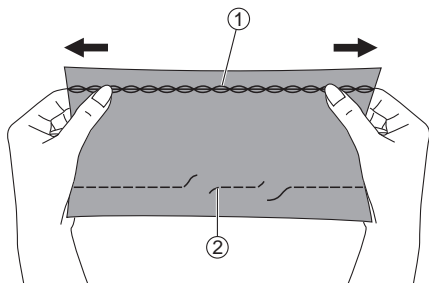

Good for easy to ravel and knit fabrics. It's good for joining durable fabric such as denims.

These stitches can also be used as a decorative top stitches.

- ① Stretch stitch
- ② Straight stitch



Using the all purpose foot.

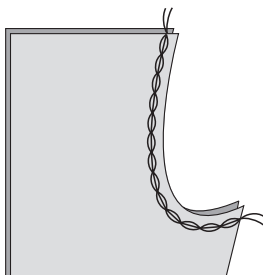

❖ Straight stretch stitch

Straight stretch stitch is used to add triple reinforcement to stretch and hardwearing seams.



Using the all purpose foot.

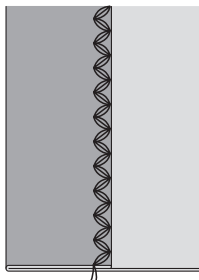

❖ Zigzag stretch stitch

Triple zigzag stretch stitch is suitable for firm fabrics like denim, poplin, etc.

Sewing stretch fabrics and elastic tape

When elastic tape is attached to the cuff or waist of a piece of clothing, the finished dimensions will be that of the stretched elastic tape. Therefore, it is necessary that a suitable length of the elastic tape be used.

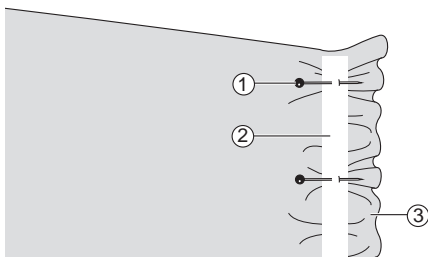
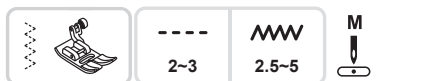

Using the all purpose foot.

Pin the elastic tape to the wrong side of fabric at a few points to make sure that the tape is uniformly positioned on the fabric.

- ① Pin
- ② Elastic tape
- ③ Wrong side

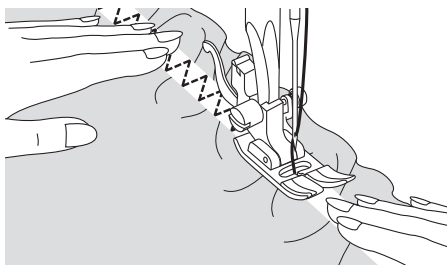

Sew the elastic tape to the fabric while stretching the tape so that it is the same length as the fabric.

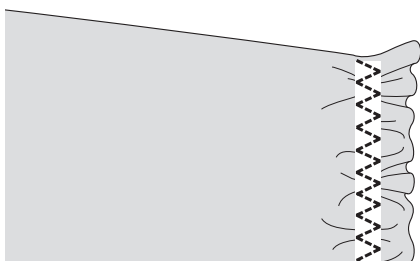

While pulling the fabric behind the presser foot with your left hand, pull the fabric at the pin nearest the front of the presser foot with your right hand.

Note

When sewing, be sure that the needle does not touch any pins, otherwise the needle may bend or break.

Overcasting stitch

Sewing overcasting stitches along the edge of fabric to prevent it from fraying.

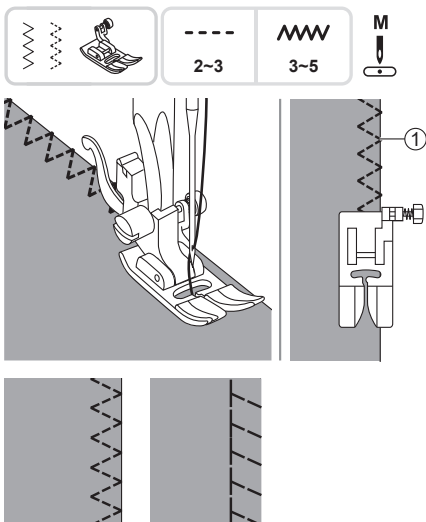

Using the all purpose foot.

Sewing the overcasting along the edge of the fabric so that the needle drops over the edge of the fabric on the right side.

① Needle drop point

Blind Hem

Secure the bottom of skirts and pants with a blind hem, this stitch will sew with invisible stitch on the right side of the fabric.



Using the all purpose foot.

..... Blind hem/lingerie for firm fabrics.

..... Blind hem for stretch fabrics.

Note

Please use the same fabric of the project and do a sewing test in advance.

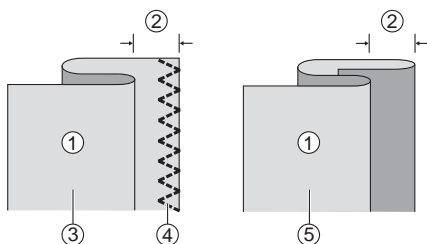

Fold the fabric as illustrated with the wrong side up.

- ① Wrong side
- ② 5mm
- ③ For heavy weight fabric
- ④ Overcasting stitch
- ⑤ For light/medium weight fabric

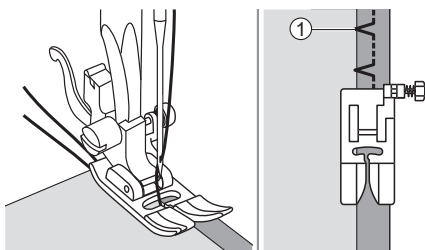

Place the fabric under the foot. Turn the handwheel forwards until the needle swings fully to the left. It should just pierce the fold of the fabric.

- ① Needle drop point

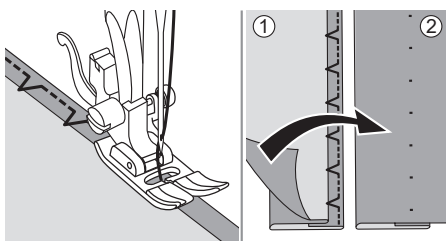

Sew slowly, guiding the fabric carefully along the edge of the guide.

Turn over the fabric.

- ① Wrong side
- ② Right side

4-Step Buttonhole stitch

Buttonholes can be adapted to the size of the button.

For stretch fabric or thin fabric, it is recommended to use a stabilizer for a better buttonhole sewing. Slightly reduce upper thread tension to produce better results.



Using the buttonhole foot.

Note

Please use the same fabric of the project and do a sewing test in advance.

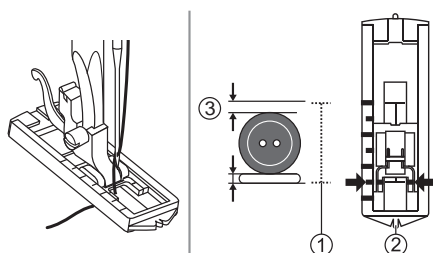

Measure diameter and thickness of button and add 3mm for bartacks to obtain correct buttonhole length; mark buttonhole size on fabric.

Place fabric under the foot, so that marking on the buttonhole foot aligns with starting marking on fabric. Lower the foot, so that the buttonhole center line marked on the fabric aligns with the center of the buttonhole foot.

- ① Buttonhole size
- ② Buttonhole foot center
- ③ 3mm

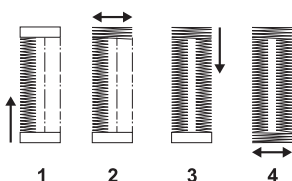

Follow the 4-step sequence changing from one step to another with the pattern selector dial. When moving from step to step through the buttonhole process, be sure that the needle is raised before turning the pattern selector dial to the next step. Take care not to sew too many stitches in steps 1 and 3.

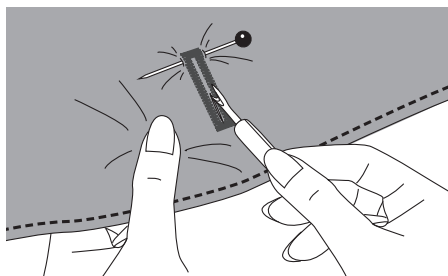

Cut the center of the buttonhole being careful not to cut any stitches on either side. Use a pin as a stopper at the bar tack so you do not cut too much.

Note

When cutting the buttonhole with the seam ripper, do not place your hands in the cutting direction, otherwise injuries may result.

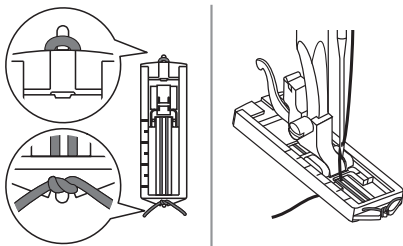

❖ Making a buttonhole on stretch fabrics

When sewing buttonholes on stretch fabric, hook heavy thread or cord under the buttonhole foot.

Attach the buttonhole foot. Bring the two gimp thread ends to the front of the foot and insert them into the grooves, then tie them there temporarily. Lower the presser foot and start sewing.

Set the stitch width to match the diameter of the gimp thread.

Once sewing is completed, pull the gimp thread gently to remove any slack. Cross the gimp in front of the needle and thread gimp ends into a large needle, pull to the wrong side and knot ends before cutting excess.

① Wrong side

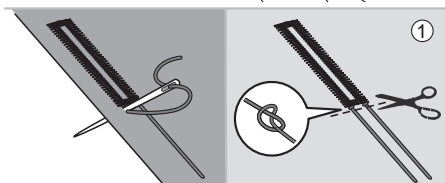
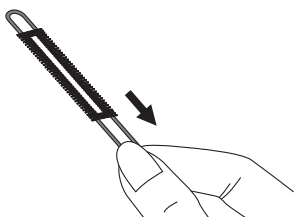

Note

It is suggested that you sew with a stabilizer material under the fabric.

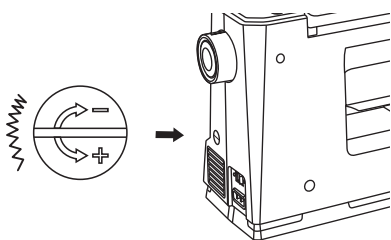

❖ Left and right side balance for buttonhole

Stitch density on right and left sides of buttonhole can be adjusted by buttonhole balance control dial.

This dial should usually be in a neutral position (between "+" and "-")

If the stitches on the left side of buttonhole are too close together, turning dial to the left opens left side (+).

If the stitches on the left side of the buttonhole are too open, turning dial to right closes left side (-).

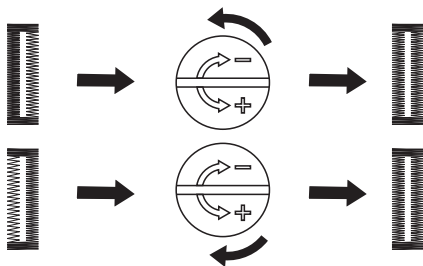

Button sewing

Buttons can be sewn on with the sewing machine. Buttons with 2 or 4 holes can be attached.

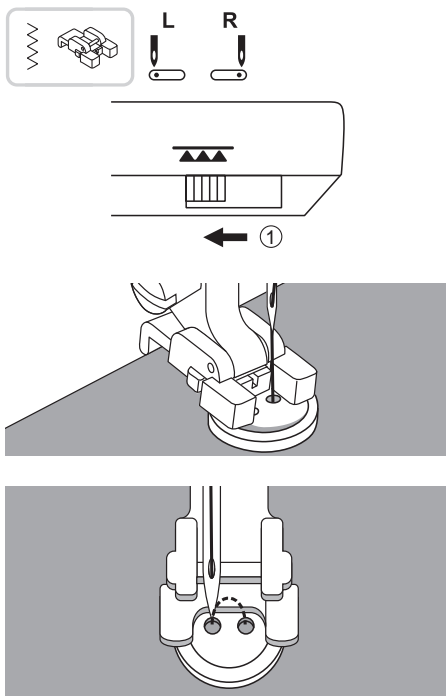

Using the button sewing foot.

Move the drop feed lever to lower the feed dogs.

① Lowered position

Put the work under the foot and place the button in desired position, then lower the foot.

Select the straight stitch and sew a few securing stitches.

Machine model without width dial: Select the zig-zag stitch width according to the distance between the two holes of the button.

Machine model with width dial: Select the zig-zag stitch and adjust the stitch width according to the distance between the two holes of the button.

Turn the handwheel to check that the needle goes cleanly into the left and right holes of the button.

Slowly sew on the button with about 10 stitches. Select the straight stitch and sew a few securing stitches.

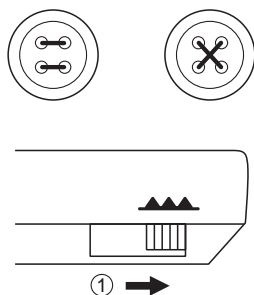

For buttons with 4 holes, sew through the front two holes first, push work forward and then sew through the back two holes.

When you finish the work, move the drop feed lever to raise the feed dogs.

① Raised position

Zipper insertion

This foot can be set to sew on each side of the zipper, the edge of the foot guides the zipper to ensure straight placement.



Using the zipper foot.

⚠ Attention

Zipper foot should be used for sewing straight stitches only. It is possible that the needle could hit the presser foot and break when sewing other patterns.

When sewing, be sure that the needle does not touch the zipper, otherwise the needle may bend or break.

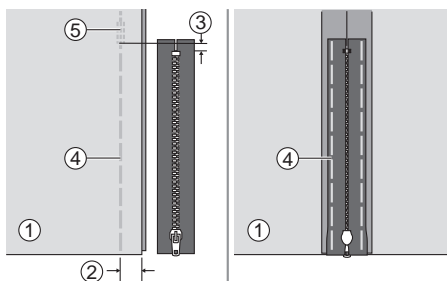

❖ Inserting a centered zipper

Place the right sides of the fabric together. Sew a bottom seam 2cm from the right edge of the zipper bottom stop position. Sew few reverse stitches for fixed. Increase the stitch length to maximum, set the tension below 2 and baste the remaining length of the fabric.

Press open the seam allowance. Place the zipper face down on the seam allowance with the teeth against the seam line. Baste the zipper tape in place.

- ① Wrong side
- ② 2cm
- ③ 5mm
- ④ Basting
- ⑤ Reverse stitches

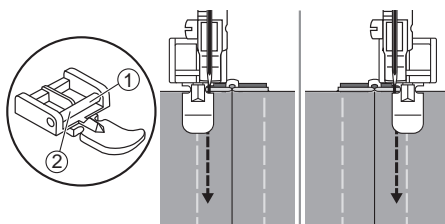

Attach the zipper foot.

- ① Attach the right pin for sewing the left side of the zipper.
- ② Attach the left pin for sewing the right side of the zipper.

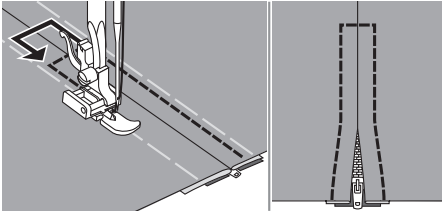

Stitching around the zipper. Remove the basting and press.

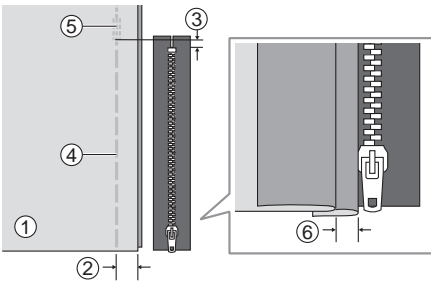

❖ Inserting a side zipper

Place the right sides of the fabric together. Sew a bottom seam 2cm from the right edge of the zipper bottom stop position. Sew few reverse stitches for fixed. Increase the stitch length to maximum, set the tension below 2 and baste the remaining length of the fabric.

Fold back to the left the seam allowance. Turn under the right the seam allowance to form a 3mm fold.

- ① Wrong side
- ② 2cm
- ③ 5mm
- ④ Basting
- ⑤ Reverse stitches
- ⑥ 3mm

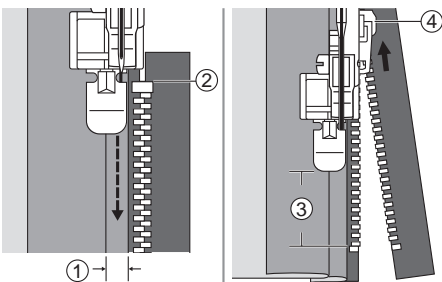

Attach the zipper foot. Attach the right pin for sewing the left side of the zipper. Sew the zipper to the piece of fabric with the extra 3mm, starting from the end of the zipper.

Stop the machine about 5cm from the top of the zipper. Lowered the needle into the fabric, raise the presser foot lever, and then open the zipper and continue sewing.

- ① 3mm
- ② The end of zipper
- ③ 5cm
- ④ Zipper

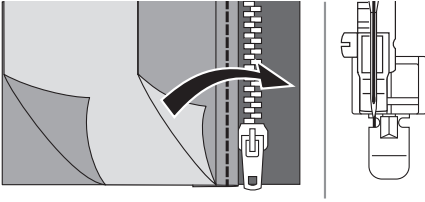

Turn the fabric right side out. Attach the left pin for sewing the rightside of the zipper.

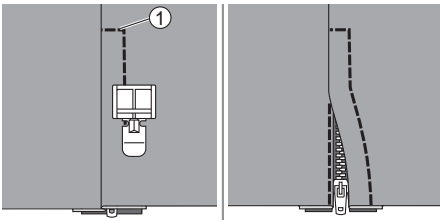

Stitch across the lower end and the right side of the zipper.

① Lower end

Stop the machine about 5cm from the top of the zipper. Remove the basting and open the zipper. Stitch the remaining of the seam.

Gathering

Ideal for clothing as well as home decor. It works best on thin to medium weight fabrics.

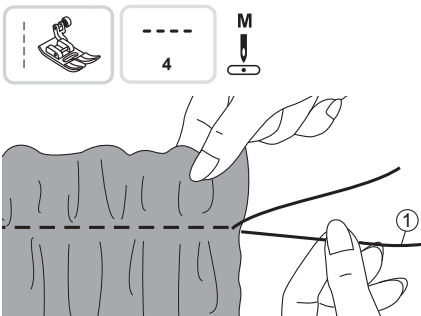

Using the all purpose foot.

Before sewing, please check the upper and bobbin threads are already pulled out about 5cm to leave enough room for sewing. Please refer to "Bringing up the bobbin thread " chapter for more information.

Set the tension below 2. Sew a single row (or many rows) of straight stitches.

Pull the bobbin threads and distribute the gathers evenly. Secure the threads at the other end.

① Bobbin thread

Smocking

The decorative stitch created by stitching or embroidering over gathers is called "smocking". It is used to decorate the front of blouses or cuffs. The smocking stitch adds texture and elasticity to the fabric.

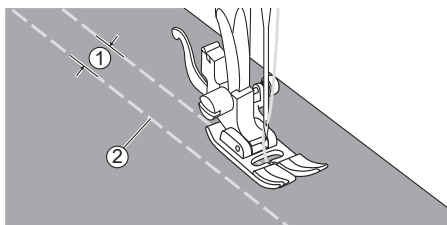

Using the all purpose foot.

Increase the stitch length to maximum, set the tension below 2 and basting lines 1cm across the area to be smocked.

- ① 1cm
- ② Basting

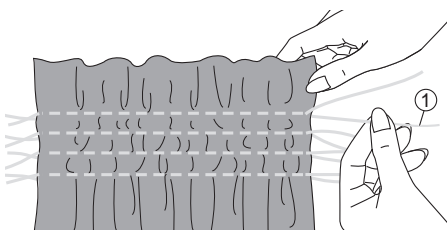

Knot the threads along one edge.

Pull the bobbin threads and distribute the gathers evenly. Secure the threads at the other end.

- ① Bobbin thread

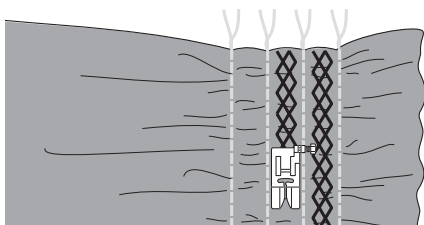

Reduce the tension if necessary and sew decorative pattern stitches between the straight seams.

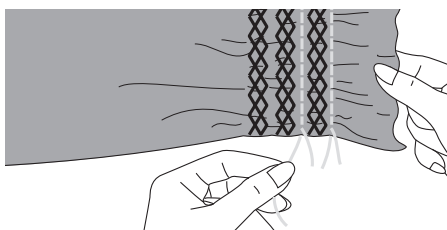

Pull out the basting.

Free motion darning, embroidery and monogramming

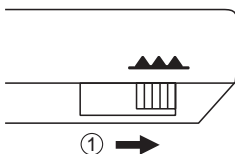
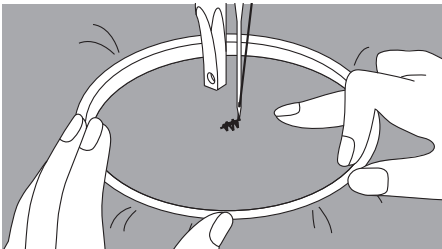
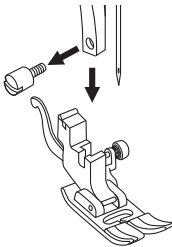
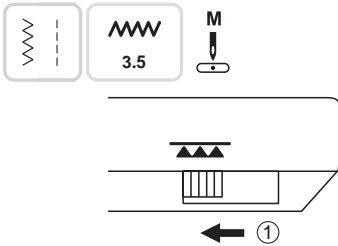

❖ Preparation for embroidering and monogramming

* Embroidery hoop is not included with the machine.

Move the drop feed lever to lower the feed dogs.

① Lowered position

Remove the presser foot and the presser foot holder.

Draw the desired lettering or design on the surface of the fabric.

Stretch the fabric between the embroidery hoop as firmly as possible.

Place the fabric under the needle. Make sure the presser foot bar is down to its lowest position.

Turn the handwheel towards you to bring up the bobbin thread through the fabric. Sew a few securing stitches at the starting point.

Hold the hoop with thumb and forefinger of both hands while pressing the material with the middle and third finger and supporting the outside of the hoop with your small finger.

▲ Attention

Keep fingers away from moving parts, especially needles.

Note

When you finish the work, move the drop feed lever to raise the feed dogs.

① Raised position

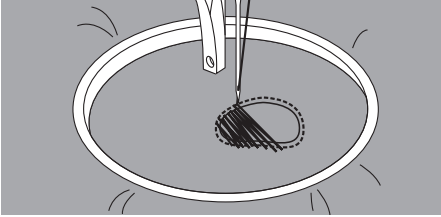

❖ Darning

First sew around the edges of the hole to secure the threads. Working from left to right, sew over the hole in a constant and continuous movement.

Turn the work by 1/4 and sew over the first stitching moving the work slower over the hole to separate the threads and not form big gaps between the threads.

Note

Free motion darning is accomplished without the sewing machine internal feed system. Movement of the fabric is controlled by the operator. It is necessary to coordinate sewing speed and movement of fabric.

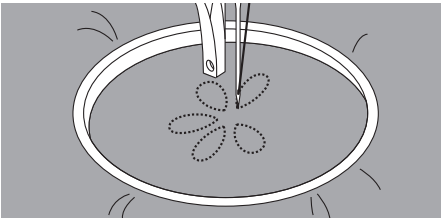

❖ Embroidery

Stitch along the outline of the design by moving the embroidery hoop. When sewing, make sure to maintain a constant speed.

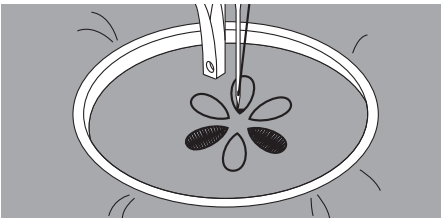

Fill in the design working from the outline towards the inside. Keep the stitches close together.

You will get longer stitches by moving the hoop faster and shorter stitches by moving the hoop slower.

Secure with reinforcement stitches at the end of the design.



❖ Monogramming

Sew at constant speed, moving the embroidery hoop slowly along the lettering.

When the letter is finished, secure with reinforcement stitches at the end of the design.

Quilting

Sandwich batting between the top and bottom layers of fabric is call "Quilting". The top layer is usually formed by multiple geometrically shaped pieces of materials joined together.



Using the all purpose foot with edge/quilting guide.

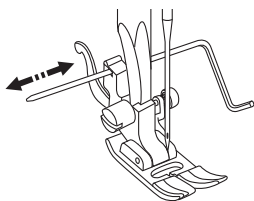

❖ Using the edge/quilting guide

Attach the edge/quilting guide in the presser foot holder as illustrated and set the space as you desire.

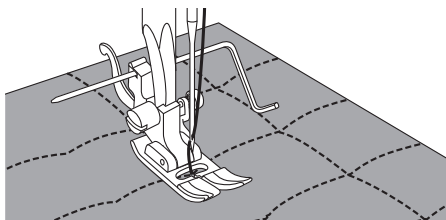

Sew the first row and move over the fabric to sew successive rows with the guide riding along the previous row of stitching.



Using the all purpose foot.

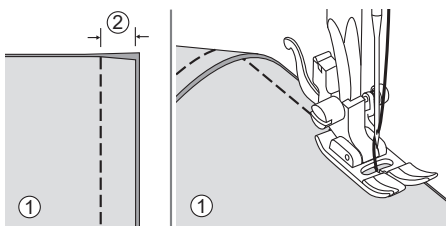

❖ Joining the pieces of the fabric

Place the two pieces of fabric with the right side together and sew with the straight stitch.

Join the pieces of fabric with a seam allowance of 5mm.

Sew with the side of the presser foot aligned with the edge of the fabric.

- ① Wrong side
- ② 5mm

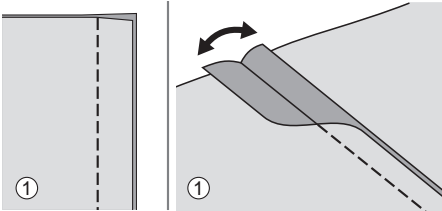

Using the all purpose foot.

❖ Patchwork stitching

Place the two fabrics, right sides together and sew using a straight stitch.

Open the seam allowance and press it flat.

① Wrong side

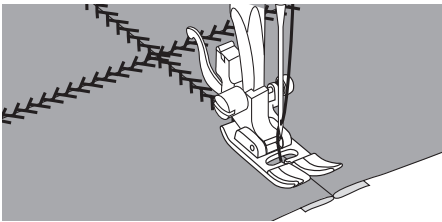

Working on the right side of the fabric, place the center of the presser foot on the seam line of the joined fabrics and stitch over the seam.

Non-stick foot

Due to the special coating on the bottom of this foot, it's perfect for sewing hard-to-feed fabrics, like leather, foam, plastic, imitation leathers and plastic-coated fabrics, such as leather or vinyl.

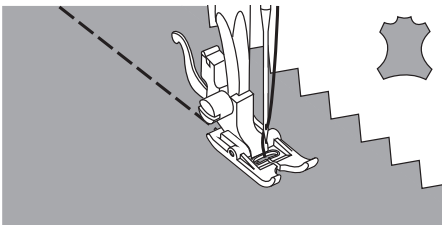

Using the non-stick foot.

Select desired stitch.

Sew slowly and guide the layers.

Applique

You can create and applique by cutting a different piece of fabric into a shape and using it as a decoration.

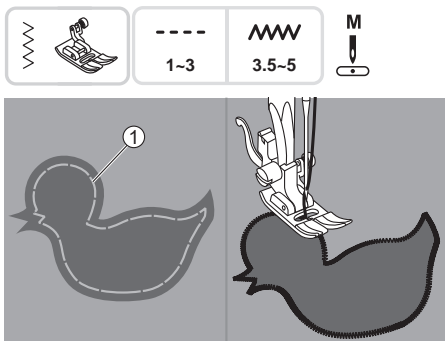

Using the all purpose foot.

Cut out the applique design and baste it on the fabric. Sew slowly around the edge of the design.

① Basting

Trim the excess material outside the stitching. Make sure not to cut any stitches. Remove the basting.

Fagoting

Stitching across an open seam is called "fagoting". It is used on blouses and children's clothing. This stitch is more decorative when thicker thread is used.

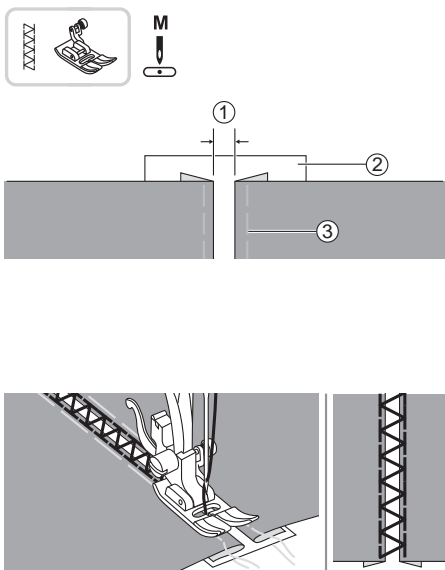

Using the all purpose foot.

Separate the folded edges of the fabric pieces with a gap of 4mm and baste them onto a piece of thin paper or water-soluble stabilizer sheet.

① 4mm

② Thin paper or water-soluble stabilizer

③ Basting

Align the center of the presser foot with the center of the two pieces of fabric and begin sewing.

After sewing, remove the stabilizer and basting.

Scallop stitch

The wave-shaped repeating pattern, that looks like shells, is called "scalloping". It is used to decorate the collar of blouses and the edges of knitting projects.

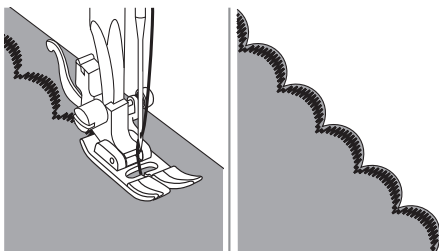

Using the all purpose foot.

❖ Scallop edging

Stitch along the edge of the fabric, making sure not to sew directly on the edge of the fabric.

For better results, apply spray starch onto the fabric and press with a hot iron before it is sewn.

Trim the fabric close to the stitching taking care not to cut the stitches.

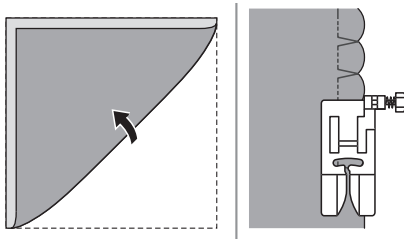

Using the all purpose foot.

❖ Shell tuck stitching

Use a lightweight fabric (tricot, for example).

Fold the fabric along the bias.

When the needle swings to the right, allow the needle to just clear the folded edge of the fabric.

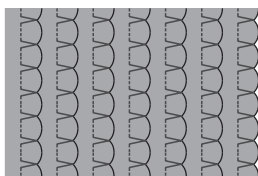

After stitching, open the fabric and iron press the tucks flat to one side.

Twin needle

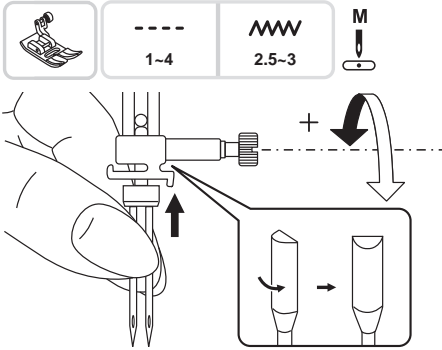

Using the all purpose foot.

⚠ Attention

If the machine have no stitch width dial, only can use the straight stitch of the center needle position, the twin needle may bend or break if the wrong stitch pattern is used. Carefully turn the handwheel to check that the twin needle enters the stitch hole without touching or even striking the stitch plate or pressure foot.

Insert the twin needle. Please refer to "Replacing the needle" chapter for more information.

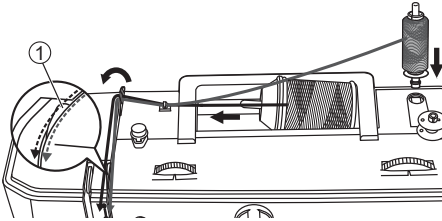

Set the second spool pin into the hole on the top of the machine. Thread both threads as usual.

Individual threading, the thread on the horizontal spool pin is to thread through the left side of silver discs, and the thread on the second spool pin is to thread through the right side of silver discs.

① silver discs

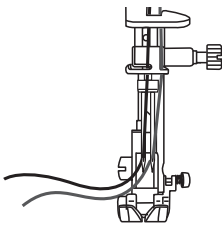

Place one thread into the slot on the left side of the needle thread guide and the other thread into the slot on the right side of the needle thread guide.

Note

Make sure that the two threads used to thread the twin needle are of the same weight. You can use one or two colors.

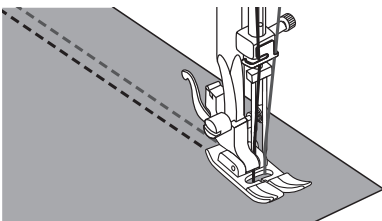

Two lines of stitching are sewn parallel to each other.

Note

When sewing with twin needle, always proceed slowly, and make sure to maintain a low speed to insure quality stitching.



Maintenance and Trouble shooting

Maintenance

⚠ Attention

Disconnect the power cord from the wall socket before carrying out any maintenance, otherwise injury or electrical shock may result.

❖ Clean the machine surface

If the surface of the sewing machine is dirty, lightly soak a cloth in mild detergent, squeeze it out firmly and then wipe the surface. After cleaning it once in this way, wipe the surface again with a dry cloth.

Do not use any organic solvents or detergents

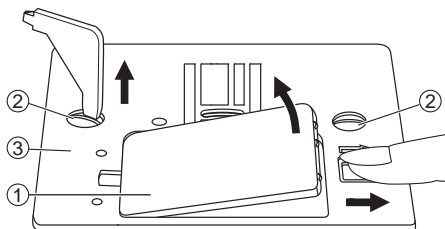

❖ Clean the hook

If lint and bits of thread accumulate in the hook, this will interfere with the smooth operation of the machine. Check regularly and clean the stitching mechanism when necessary.

Remove the needle, presser foot and presser foot holder.

Remove the bobbin cover and bobbin.

Remove the screws on the needle plate then remove the needle plate.

- ① Bobbin cover
- ② Screws
- ③ Needle plate

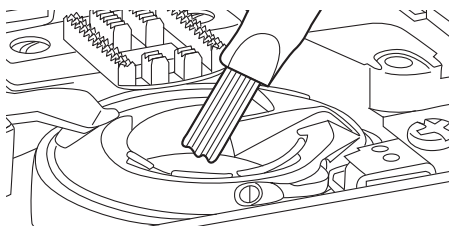

Clean the feed dogs and bobbin case with a brush. And also use a soft and dry cloth to clean them.

Trouble shooting guide

Before calling for service, check below trouble shooting guides in advance, if problem still exist, please contact nearest dealer or local service center.

Problem	Cause	Correction	Reference
Upper thread breaks	1. The machine is not threaded correctly.	1. Rethread the upper thread.	11
	2. The thread tension is too tight.	2. Reduce the thread tension (to lower number).	18
	3. The thread is too thick for the needle.	3. Select a larger needle size.	15
	4. The needle is not inserted correctly.	4. Remove and reinsert the needle (flat side towards the back).	14
	5. The thread is wound around the spool holder pin.	5. Remove the reel and wind up the thread onto the reel.	11
	6. The needle is damaged.	6. Insert a new needle.	14
Bobbin thread breaks	1. The bobbin case is not inserted correctly.	1. Remove and reinsert the bobbin case and pull on the thread.	10
	2. The bobbin case is threaded wrong.	2. Check both bobbin and bobbin case if on the correct position.	10
Skipped stitches	1. The needle is not inserted correctly.	1. Remove and reinsert the needle (flat side towards the back).	14
	2. The needle is damaged.	2. Insert a new needle.	14
	3. The wrong size needle has been used.	3. Choose a needle to suit the thread.	15
	4. The presser foot is not attached correctly.	4. Check and attach it correctly.	16
	5. The machine is not threaded correctly.	5. Rethread the upper thread.	11
Needle breaks	1. The needle is damaged.	1. Insert a new needle.	14
	2. The needle is not correctly inserted.	2. Insert the needle correctly (flat side towards the back).	14
	3. Wrong needle size for the fabric.	3. Choose a needle to suit the thread and fabric.	15
	4. The wrong presser foot is attached.	4. Select the correct presser foot.	-
	5. The needle clamp screw is loose.	5. Use the screwdriver to tighten the screw.	14
	6. The presser foot is not appropriate for the type of stitch that you sew.	6. Attach appropriate presser foot for the type of stitch that you sew.	-
	7. The upper thread tension too tight.	7. Loosen the upper thread tension.	18

Problem	Cause	Correction	Reference
Loose stitches	1. The machine is not correctly threaded.	1. Check the threading and rethread.	11
	2. The bobbin case is not threaded correctly.	2. Thread the bobbin case as illustrated.	8
	3. Needle/fabric/thread combination is wrong.	3. The needle size must suit the fabric and thread.	15
	4. The thread tension is wrong.	4. Correct the thread tension.	18
Seam gather or pucker	1. The needle is too thick for the fabric.	1. Select a correct needle size.	15
	2. The stitch length is wrong.	2. Adjust the stitch length.	22
	3. The thread tension is too tight.	3. Loosen the thread tension.	18
Seam puckering	1. The needle thread tension is too tight.	1. Loosen the thread tension.	18
	2. The needle thread is not threaded correctly.	2. Rethread the machine.	11
	3. The needle is too heavy for the fabric being sewn.	3. Choose a needle to suit the thread and fabric.	15
	4. The stitch length is too long for the fabric.	4. Adjust the stitch length shorter.	22
	5. Sewing on thin fabric.	5. Sew with a stabilizer material under the fabric.	26
Patterns are distorted	1. The presser foot is not suited for the pattern.	1. Select the correct foot.	-
	2. The needle thread tension is too tight.	2. Loosen the thread tension.	18
Thread has jammed	1. Thread is caught in the hook.	Remove the upper thread and bobbin case, turn the handwheel backwards and forwards and remove the thread remnants.	48
	2. The feed dogs are packed with lint.		
The machine is noisy	1. Fluff or oil have collected on the hook or needle bar.	1. Clean the hook and feed dog.	48
	2. The needle is damaged.	2. Insert a new needle.	14
	3. Thread is caught in the hook.	Remove the upper thread and bobbin case, turn the handwheel backwards and forwards and remove the thread remnants.	48
	4. The feed dogs are packed with lint.		
Uneven stitches, uneven feed	1. Poor quality thread.	1. Select a better quality thread.	15
	2. The bobbin case is threaded incorrect.	2. Remove the bobbin case and the thread and reinsert them correctly.	8
	3. Fabric has been pulled on.	3. Do not pull on the fabric while sewing, let it be taken up by the machine.	-

Problem	Cause	Correction	Reference
The sewing machine doesn't operate	1. The machine is not turned on.	1. Turn on the machine.	4
	2. The presser foot lifter is raised.	2. Lower the presser foot lifter.	6
	3. The machine is not plugged in.	3. Connect the power cord to the electric outlet.	4





Do not dispose of electrical appliances as unsorted municipal waste, use separate collection facilities.

Contact your local government for information regarding the collection systems available.

If electrical appliances are disposed of in landfills or dumps, hazardous substances can leak into the groundwater and get into the food chain, damaging your health and well-being.

When replacing old appliances with new ones, the retailer is legally obligated to take back your old appliance for disposal at least for free of charge.